

ZION Series

Half-Cell Monofacial Module

445-460Wp | **21.16%**
Module Power Output | Max Efficiency



Key Features



High module conversion efficiency



Better temperature coefficient



Super multi busbar technology



Low attenuation long warranty



Superior load capacity



Aesthetic appearance



USA based liability insurance



Houston, Texas based company



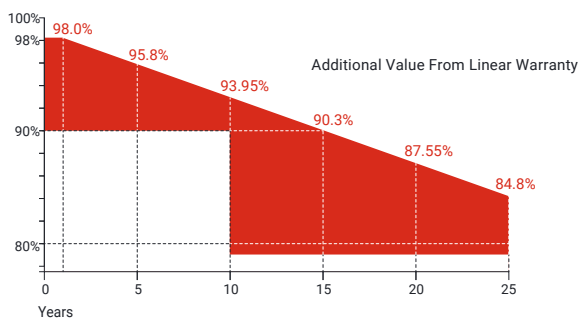

Warranty



15 Years Guarantee on product material and workmanship

25 Years Linear power output warranty

Product Certification

IEC61215; IEC61730; UL61730	
IEC62804	PID
IEC61701	Salt Mist
IEC62716	Ammonia Resistance
IEC60068	Dust and Sand
IEC61215	Hailstone
Fire Type (UL61730): Type 1	
ISO14001:2015; ISO9001:2015; ISO45001:2018	
	
	
	
	

About SEG Solar

Founded in 2016, SEG is a leading vertically integrated PV manufacturer headquartered in Houston, Texas, U.S., and is dedicated to delivering reliable and cost-effective solar modules to the utility, commercial and residential markets. By the end of 2023, SEG has shipped over 5 GW of solar modules worldwide. The company is expected to exceed a production capacity of 5.5 GW by the end of 2024.



Download Datasheet

Electrical Characteristics

Module Type	SEG-445-BMA-HV		SEG-450-BMA-HV		SEG-455-BMA-HV		SEG-460-BMA-HV	
	Front STC	Front NOCT	Front STC	Front NOCT	Front STC	Front NOCT	Front STC	Front NOCT
Maximum Power -Pmp(Wp)*	445	334	450	338	455	342	460	346
Open Circuit Voltage -Voc(V)	49.90	46.60	50.10	46.80	50.30	46.90	50.50	47.10
Short Circuit Current -Isc(A)	11.34	9.17	11.42	9.22	11.49	9.29	11.57	9.34
Maximum Power Voltage -Vmp(V)	41.60	38.50	41.80	38.70	42.00	38.90	42.20	39.10
Maximum Power Current -Imp(A)	10.70	8.68	10.77	8.73	10.84	8.80	10.91	8.85
Module Efficiency(%)	20.47		20.70		20.93		21.16	
Power Tolerance(W)				(0, +4.99)				
Maximum System Voltage				1500V DC				
Maximum Series Fuse Rating				20 A				

STC: Irradiance 1000 W/m² module temperature 25°C AM=1.5
 *Measuring tolerance: ±3%

NOCT: Irradiance 800W/m² ambient temperature 20°C module temperature 45°C wind speed: 1m/s

Mechanical Specifications

External Dimension	2094 x 1038 x 35 mm
Weight	23.5 kg
Solar Cells	PERC Mono 144 pcs(72 x 2)
Front Glass	3.2 mm AR coating tempered glass
Frame	Anodized aluminium alloy
Junction Box	IP68 / 3 diodes
Connector Type	PV-C002-xy or MC4
Cable Type	12 AWG PV Wire(UL)
Cable Length	Portrait: 400 mm(+) / 200 mm(-) Landscape: 1200 mm(+) / 1200 mm(-) or customized length
Mechanical Load(Front)	5400 Pa / 113 psf*
Mechanical Load(Rear)	2400 Pa / 50 psf*

*Refer to SEG installation manual for details

Technical Drawing

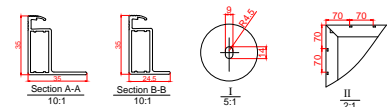
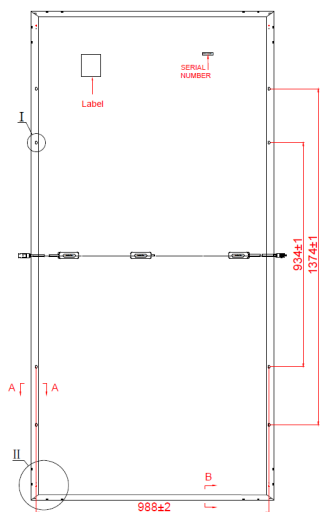
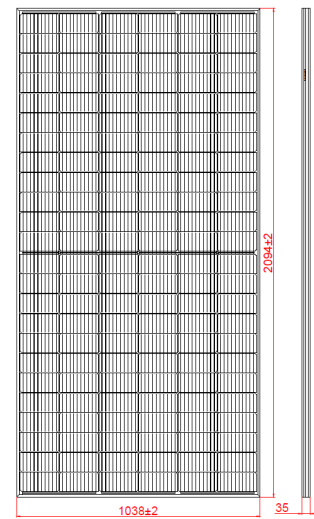

*Refer to SEG installation manual for details

Temperature Characteristics

Pmax Temperature Coefficient	-0.35 %/°C
Voc Temperature Coefficient	-0.27 %/°C
Isc Temperature Coefficient	+0.05 %/°C
Operating Temperature	-40~+85 °C
Nominal Operating Cell Temperature (NOCT)	45±2 °C

Packing Configuration

Container*	20'GP	40'HQ
Pieces per Pallet	31	31
Pallets per Container	5	22
Pieces per Container	155	682

*Refer to the SEG container technical documentation for 53' box trailer or other trucks loading quantity

Curves of PV Module

